



**Yealink Network Technology CO., LTD**

## **Yealink VC110 Video Conferencing Endpoint Quick Start Guide**

**V10.6**

**Applies to 50.10.0.6 firmware version or later**

# Table of Contents

Packaging Contents	1
VC110-All-in-one Unit Connection Diagram	2
Remote Control and Cable Ties Installation	4
VC110-All-in-one Unit Installation	5

Cable Hub Connection Diagram	7
Main Screen	8
Network Deployment	9
Troubleshooting	12

# Packaging Contents

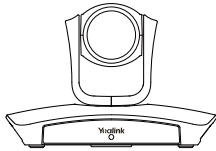

VC110 All-in-one Unit

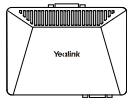

Cable Hub



Remote Control  
AAA Batteries × 2

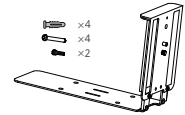

VC110 Installation Accessories



DVI Cable

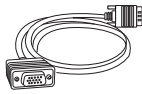

VGA Cable

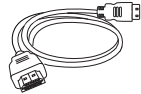

HDMI Cable × 1

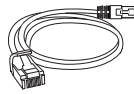

Ethernet Cable  
(2m)



Power Adapter

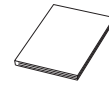

Quick Start Guide



Cable Ties × 5



Velcro × 2



VCM60



Dongle



Power  
Adapter



USB Cable



Quick Start  
Guide

Wireless Microphone Package



VCP40

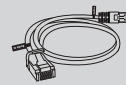

Ethernet Cable  
(7.5m)

Video Conferencing Phone Package



VCM30

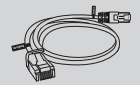

Ethernet Cable  
(7.5m)

Microphone Array Package



Please use the Yealink-customized DVI cable (only for VC110)



VC110 all-in-one unit can work with the VCM60, VCP40 or VCM30. You can purchase any combination according to your needs.

# VC110 All-in-one Unit Connection Diagram

- The Back of the VC110

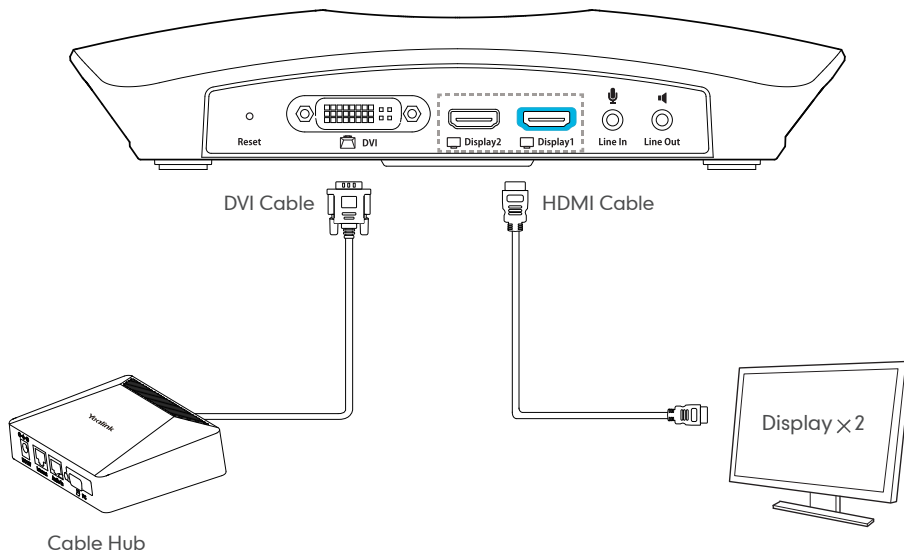

2



Please connect to Display1 port in blue color if you have only one display device



- The Right Side of the VC110

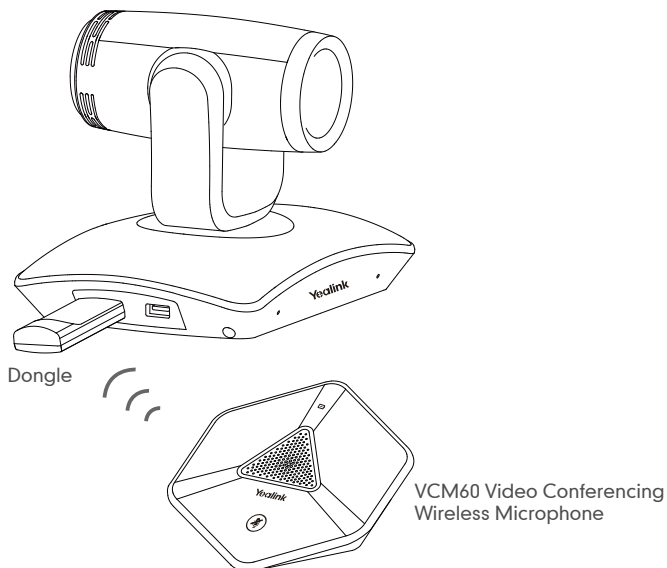

The VCM60 video conferencing wireless microphone and dongle are automatically “paired” at the factory. All you need to do is connect the dongle to one of the USB ports on the VC110 all-in-one unit. After the VCM60 is turned on, the VCM60 will register with the dongle automatically.

 For more information, refer to [Yealink VCM60 Video Conferencing Wireless Microphone Quick Start Guide](#)

# Remote Control and Cable Ties Installation

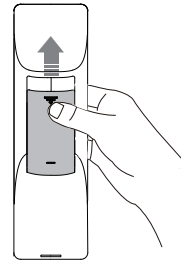
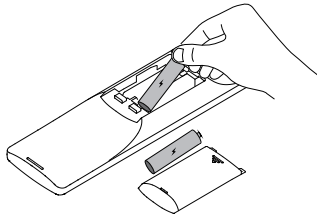

Install batteries

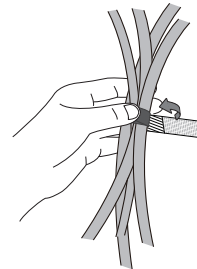
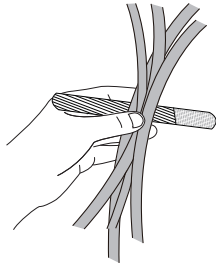

Fasten the cables with the cable tie

# VC110 All-in-one Unit Installation

- Hanging Mode

Please choose the following installation mode when the thickness of the TV is between 35-120mm.

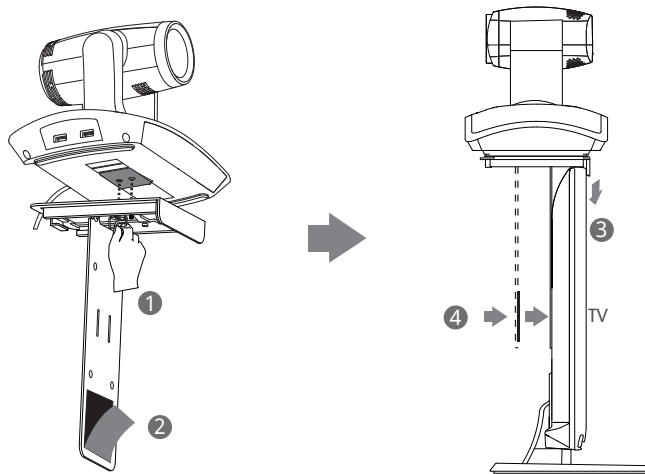

Steps: ① Lock the all-in-one unit ② Remove the protection of the Velcro ③ Install bracket ④ Make sure the back of the TV is clean, and then adjust the bracket to ensure close adhesion to the back of the TV with Velcro



Adjust the bracket to ensure close adhesion to the back of the TV.

## ● Wall-mount Mode

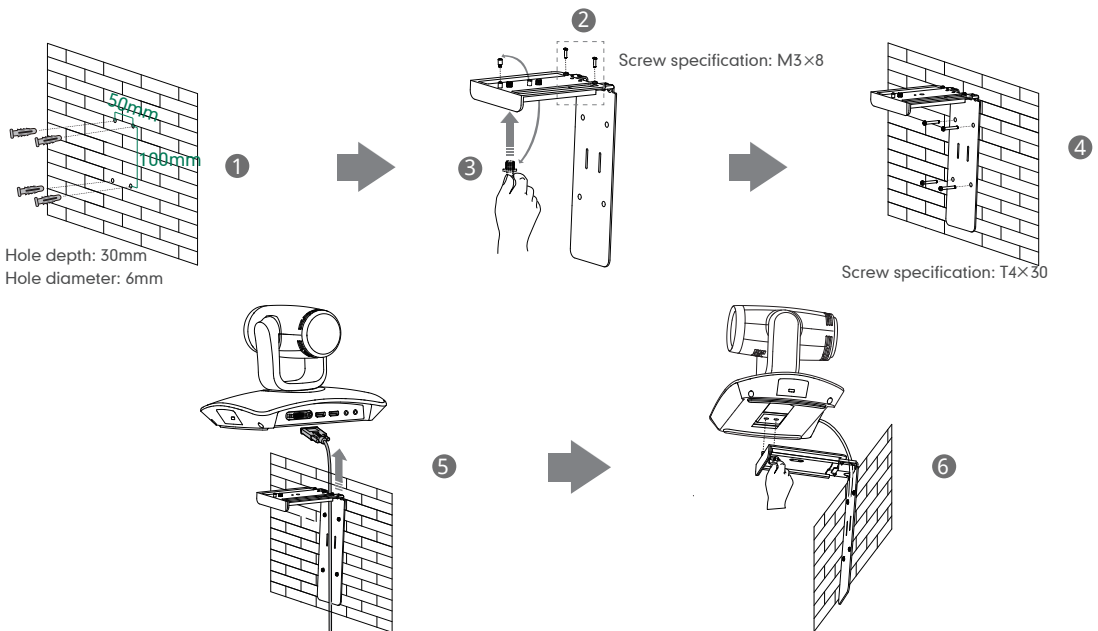

Steps: 1 Punch holes & Insert expansion bolts 2 Drive screws 3 Adjust the screw position and manually lock it 4 Insert screws to lock the bracket to the wall 5 Connect DVI cable 6 Lock the camera

6



The recommended height for VC110 all-in-one unit positioning is 1.5m-1.8m

# Cable Hub Connection Diagram

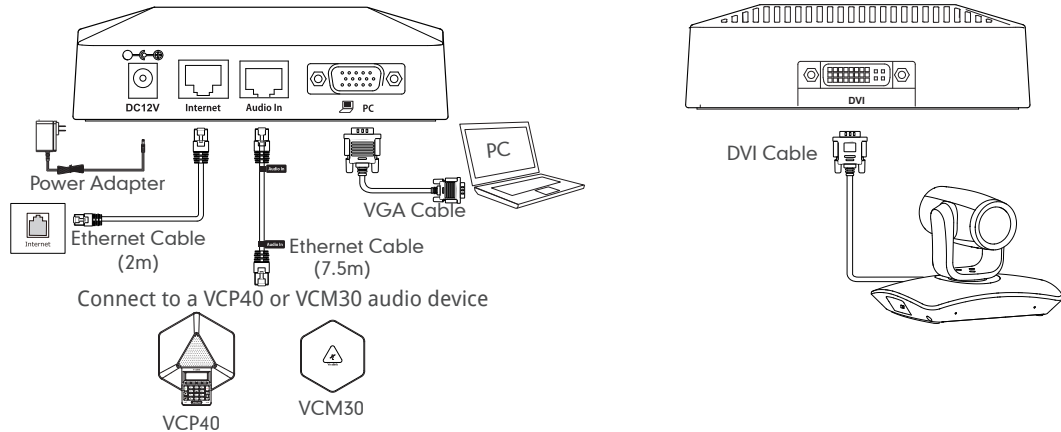

- 💡 The VC110 video conferencing endpoint should be used with Yealink original power adapter (12V/2A) only.
- 💡 The cable hub can also be powered from a PoE-compliant switch or hub.

## Wall Mount Method for the Cable Hub

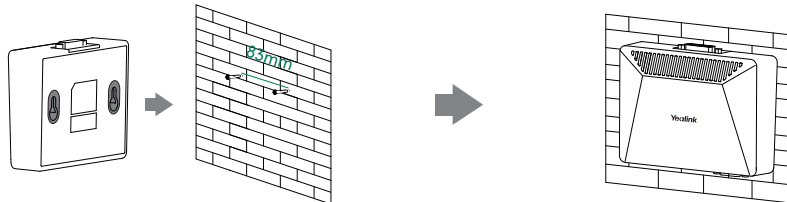

- 💡 To hang the cable hub on the wall, you need to purchase the screws (specification: T4 ×30) separately.

# Main Screen

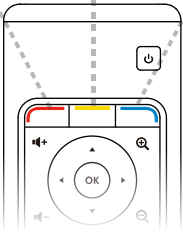

# Network Deployment

- In order to ensure that the VC110 can work properly, please configure it according to the role it plays in the meeting. If it is in the head office, please make sure that it is reachable from public network. If it is in branch office, please use intelligent firewall traversal to deploy it or just follow the same steps as in the head office

## Head Office

- At least one static public IP address is required in head office to allow branch offices to connect. Configuration suggested :
  - To deploy the VC110 on public network, you need to assign a static public IP address to it.
  - To deploy the VC110 in an Intranet, you need to assign a static private IP address behind the firewall. At the meantime, do port mapping on firewall for VC110.

## Configure a Static IP

- First of all, configure a static IP for the VC110
- For example: you can use the remote control to configure the IP 10.3.20.12 to your VC110.
  - Menu->Advanced (Admin Password: 0000)->LAN Configuration
  - Turn off the **【DHCP】**
  - Enter the IP address, subnet mask, gateway, DNS information in the corresponding fields.

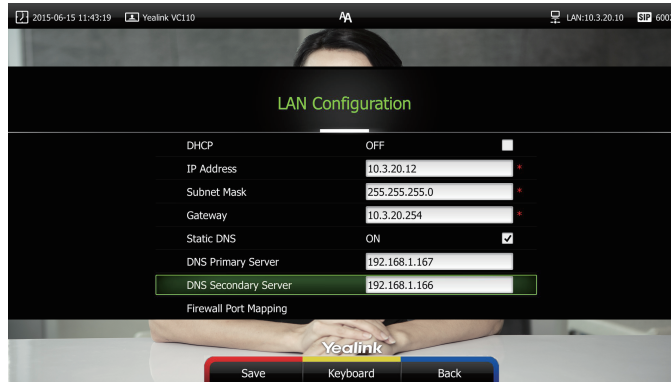

- Press **【Save】** to save the configuration, then the screen prompts **【Reboot now】** . Press **【OK】** to reboot the endpoint.

## Configure Port Mapping

If the VC110 is deployed in Intranet, you need to finish the following port mapping on the firewall:

Function	Port	Protocol Type
H.323 signal port	1719-1720	UDP/TCP
Audio & Video media stream port	50000-50499	TCP/UDP
Web management port ( optional )	443	TCP
SIP ( optional )	5060-5061	TCP/UDP



# Branch Office

- If you are in branch office, following two options are suggested:

**Option1:** Deploy the VC110 following the same steps as in the head office. In this way, both inbound and outbound calls are available.

**Option2:** Deploy the VC110 using intelligent firewall traversal way. In this plug and play way, firewall configuration is not required, but only outbound calls are allowed.

💡 Please note that when the VC110 is deployed with intelligent firewall traversal, you have to open ports (as shown below) permission if they are restricted

💡 It is recommended that you forward the web management port (443/TCP) to the public network, so that the head office can remotely manage the branch office

Function	Port	Protocol Type
H.323 signal port	1719-1720	UDP/TCP
Audio & Video media stream port	50000-50499	TCP/UDP
SIP ( optional )	5060-5061	TCP/UDP

# Bandwidth Requirements

- To ensure the performance of video conference, the recommended bandwidth for VC110 is as below:

Video Resolution	Recommended Bandwidth
Full HD 1080P	1.3Mb
People 1080P+Content 1080P	2.6Mb

- 💡 For more information of the configurations, contact your system administrator.
- 💡 The bandwidth mentioned above is based on two-way conference. Bandwidth in head office should be increased along with the growing number of connected branch offices .

## Troubleshooting

- After the installation and deployment, you can test the VC110 by dialing Yealink Demo Room. If you can't dial out successfully, please contact your IT administrator to check the internal network configuration.
- Assume that you are A in head office and use the configuration method in "Head Office" chapter on page 9, you are able to call B in branch office or Yealink Demo, but they cannot reach you. The most likely reason is the firewall or gateway in the environment does not support H.323 ALG

feature. In this situation, please do as follows to enable NAT feature on VC110 to solve this problem.  
(Do these steps by the remote control)

- Menu->Advanced (admin password: 0000)->NAT/Firewall
- Select **【Auto】** from the **【Type】** pull-down list, the endpoint will obtain public IP address automatically.
- If the endpoint does not obtain a public IP address automatically, select **【Manual Settings】** from the **【Type】** pull-down list, and then enter the public IP address in the **【Public IP address】** field.

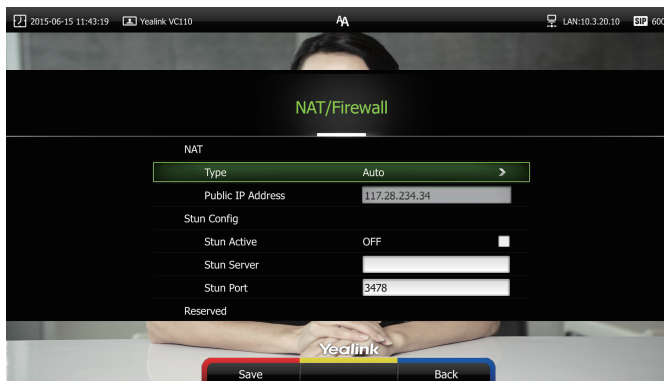

Yealink Test Room IP: 117.28.251.50、 117.28.251.51



For more information, visit the Yealink website:  
[www.yealink.com](http://www.yealink.com)



YEALINK NETWORK TECHNOLOGY CO.,LTD.  
Web: [www.yealink.com](http://www.yealink.com)  
Addr: 4th-5th Floor, South Building, No.63  
Wanghai Road, 2nd Software Park,  
Xiamen, China(361008)  
Copyright©2015Yealink Inc.All right reserved.