

High-performance SIP Cordless Phone System

W60B:

- DECT technology
- Up to 8 concurrent calls
- Up to 8 DECT cordless handsets
- Up to 8 VoIP accounts

CP930W:

- Built-in battery
- Up to 24-hour talk time
- Up to 15-day standby time
- Less than 4 hours charging time
- Optima HD voice, full duplex technology
- 20-foot (6-meter) and 360-degree microphone pickup range
- 5-way conference call
- Upgrade over the air



Eight
Concurrent Calls



TLS & SRTP
security encryption



Long
Standby Time



5-way
Conference Call



HD
Audio

Employing DECT technology, the Yealink CP930W Wireless DECT Conference Phone allows you to hold meetings wherever or whenever is convenient for you. Working with Yealink W60B base station, which owns the DECT radio coverage up to 50m indoors, CP930W can be provided with good and stable signal.

Thanks to its built-in battery and the DECT technology, CP930W entirely frees you from the network and power outlets troubles, giving you a tidy conference table with only one elegant CP930W. Also, its built-in rechargeable battery ensures up to 24 hours of call time and 15 days of standby time, guaranteeing a long working time without recharging and making CP930W totally wireless in DECT environment.

The Yealink CP930W DECT conference phone, marrying the Yealink Noise Proof Technology, unburdens the business conversation by reducing annoying noise and minimizing distractions to set audio experience into a new level. Thanks to its built-in 3-microphone array, CP930W owns a 20-foot (6-meter) and 360-degree voice pickup range as if all participants are sitting across the table from each other!

Moreover, pairing Yealink CP930W with your smartphone (via Bluetooth) or PC/tablet (via micro USB) allows you to turn the Yealink CP930W into a loudspeaker and microphone with ease that the collaboration may be easier than ever before.

DECT technology:

Yealink DECT technology is based on CAT-iq2.0, which focuses on high quality Audio VoIP (wideband), as well as low bit - rate data applications. But we are not compatible with any third-party DECT devices (base station, handset, etc.).

Phone Features

- Up to 8 simultaneous calls
- Up to 8 handset (CP930W works as a handset)
- Up to 8 SIP accounts (only one SIP account on CP930W)
- Up to 5 repeaters per base station (RT20/RT20U)
- Up to 6 repeaters per base station (RT30)
- Paging, intercom, dial plan
- Call hold, call transfer, 5-way conference (CP930W only)
- Switching between calls
- Call waiting, mute, silence, DND
- Caller ID with name and number
- Anonymous call, Anonymous call rejection
- Call forward (always/busy/no answer)
- Speed dial, voicemail, redial
- Message Waiting Indication (MWI)
- Music on hold (server-based)
- Local phonebook for up to 800 entries (store in the base, 100 entries in each handset)
- Remote phonebook/LDAP
- Phonebook search/import/export
- Call history (all/misplaced/received)
- Direct IP call without SIP proxy
- Reset to factory, reboot
- Keypad lock, emergency call
- Broadsoft directory, BroadSoft call log
- Broadworks feature key synchronization
- Shared Call Appearance (SCA)

Management

- Auto-provision via TFTP/FTP/HTTP/HTTPS/RPS
- Auto-provision with PnP
- Handset upgrade: OTA (Over-The-Air)/USB port
- Configuration: browser/phone/auto-provision
- Trace package and system log export

Audio Features

- Full-duplex speakerphone
- Receiver volume control
- Ringer volume control
- Multiple advisory tones
- Acoustic warning for low battery status

- DTMF
- Wideband codec: Opus, AMR-WB (optional), G.722
- Narrowband codec: PCMU, PCMA, G.726, G.729, iLBC
- VAD, CNG, AGC, PLC, AJB
- Support VQ-RTCPXR (RFC6035), RTCP-XR

Network Features

- SIP v1 (RFC2543), v2 (RFC3261)
- SNTP/NTP
- VLAN (802.1Q and 802.1P)
- 802.1x, LLDP, PPPoE
- STUN Client (NAT Traversal)
- UDP/TCP/TLS
- IP assignment: static/DHCP
- Support outbound proxy server backup

Security

- Open VPN
- Transport Layer Security (TLS)
- HTTPS (server/client), SRTP (RFC3711)
- Digest authentication
- Secure configuration file via AES encryption
- Support SHA256/SHA512/SHA384
- Three-level configuration mode: Admin/Var/User

DECT

- Frequency bands: 1880 - 1900 MHz (Europe), 1920 - 1930 MHz (US)
- DECT Standards: CAT-iq2.0

Interface

- 1 x RJ45 10/100M Ethernet port (W60B)
- Power over Ethernet (IEEE 802.3af), Class 1 (W60B)

Physical Features

- Indoor Range: 50m (in ideal conditions)
- Outdoor Range: 300m (in ideal conditions)
- Standby Time: 360 hours (in ideal conditions)
- Talk Time: 24 hours (in ideal conditions)
- 3.1" 248x120-pixel graphical LCD with backlight

- Sensitive touch keypad
- 25 total keys: 4 soft keys, off-hook key, on-hook key, 12-key numerical keypad, Bluetooth, mute, volume keys, 2 navigation keys, OK key
- Multilingual user interface
- Three LED indicators on W60B:
 - 1 x Registration LED
 - 1 x Network Status LED
 - 1 x Power Indicator LED
- External Yealink AC adapter: AC 100-240V Input and DC 5V/600mA Output (W60B) AC 100~240V input and DC 12V/1A output (CP930W)
- Color: CP930W:Space Silver; Base: Classic Grey
- Phone size: 307.8mm*298.5mm*66.9mm
- Base station size: 130mm x 100mm x 25.1mm
- Charging cradle size: 110mm*127mm*21.5mm
- Operating humidity: 10~90%
- Operating temperature: -0~+40°C (+32~104°F)

Package features

- Package content:
 - Yealink CP930W DECT conference phone (built-in battery)
 - Charger cradle
 - W60B Base Station
 - Base Stand
 - Two Yealink Power Adapters
 - Ethernet Cable
 - Quick Start Guide
- Qty/CTN: 5 PCS
- N.W/CTN: 9.48 kg
- G.W/CTN: 10.51 kg
- Giftbox size: 336mm*364mm*112mm
- Carton Meas: 587mm*376mm*350mm

Compliance

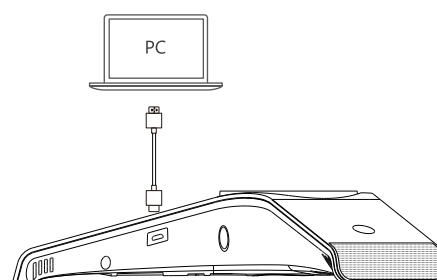
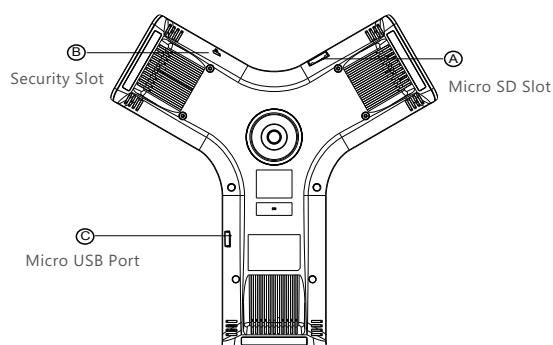



About Yealink

Yealink is a global leading provider of enterprise communication and collaboration solutions, offering video conferencing service to worldwide enterprises. Focusing on research and development, Yealink also insists on innovation and creation. With the outstanding technical patents of cloud computing, audio, video and image processing technology, Yealink has built up a panoramic collaboration solution of audio and video conferencing by merging its cloud services with a series of endpoints products. As one of the best providers in more than 140 countries and regions including the US, the UK and Australia, Yealink ranks No.1 in the global market share of SIP phone shipments.

Copyright

Copyright © 2018 YEALINK(XIAMEN) NETWORK TECHNOLOGY CO., LTD.

Copyright © 2018 Yealink(Xiamen) Network Technology CO., LTD. All rights reserved. No parts of this publication may be reproduced or transmitted in any form or by any means, electronic or mechanical, photocopying, recording, or otherwise, for any purpose, without the express written permission of Yealink(Xiamen) Network Technology CO., LTD.

Technical Support

Visit Yealink WIKI (<http://support.yealink.com/>) for firmware downloads, product documents, FAQ, and more. For better service, we sincerely recommend you to use Yealink Ticketing system (<https://ticket.yealink.com>) to submit all your technical issues.



YEALINK(XIAMEN) NETWORK TECHNOLOGY CO.,LTD.
Web: www.yealink.com
Addr: No.1 Ling-Xia North Road, High Tech Park,
Huli District, Xiamen, Fujian, P.R. China
Copyright©2018Yealink Inc. All right reserved.